

## Installation instructions



Refer to installation use and maintenance manual for more information.



## 2 phase bipolar stepper drive technical data:

- AC power supply: 18 ÷ 56 Vac
- DC logic supply: 24 Vdc (optional and not isolated)
- Phase current: up to 4.5 Apeak (3032 serie) or up to 10 Apeak (3070 serie)
- Chopper frequency: ultrasonic 40KHz
- Stepless Control Technology (65536 position per turn)
- Protections against : over current, over/under voltage, overheating, short circuit between motor phase-to-phase and phase-to-ground
- Modbus (SW4A30xxM261-02) or Canbus (SW4A30xxC261-02) communication interfaces
- Absolute encoder (not isolated): 5V BiSS-C or SSI encoder interface
- Service SCI interface for programming and real time debugging
- 4 digital inputs (opto-coupled)
- 2 digital outputs (opto-coupled)
- 2 analog inputs
- Dimensions: 146.8 x 74 x 30 mm (without connectors)
- Protection degree: IP20
- Pollution degree: 2
- Category C3 following standard EN 61800-3
- Working temperature 5°C ÷ 40°C ; Storage temperature -25°C ÷ 55°C
- Humidity: 5% ÷ 85% not condensing

**TITANIO**  
VECTOR - STEPPER - DRIVES

error  
less  
servo  
efficient  
**else**  
technology  
by Ever Electronics



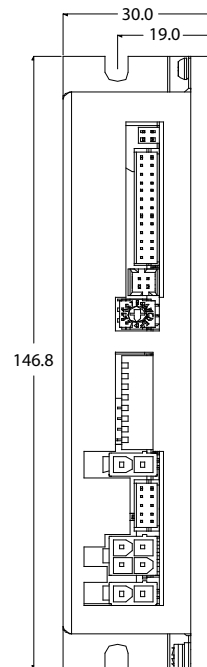
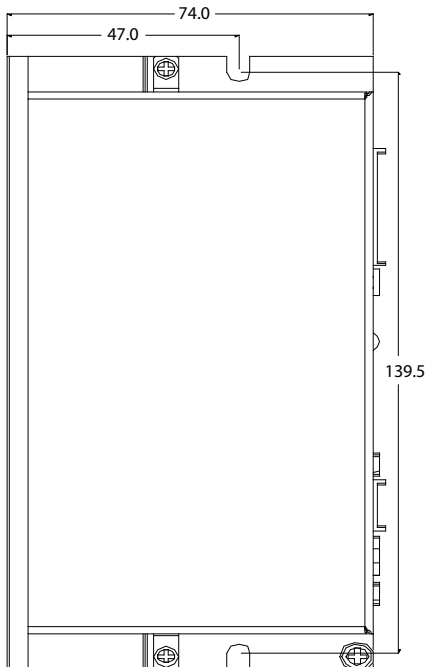

## Mechanical data

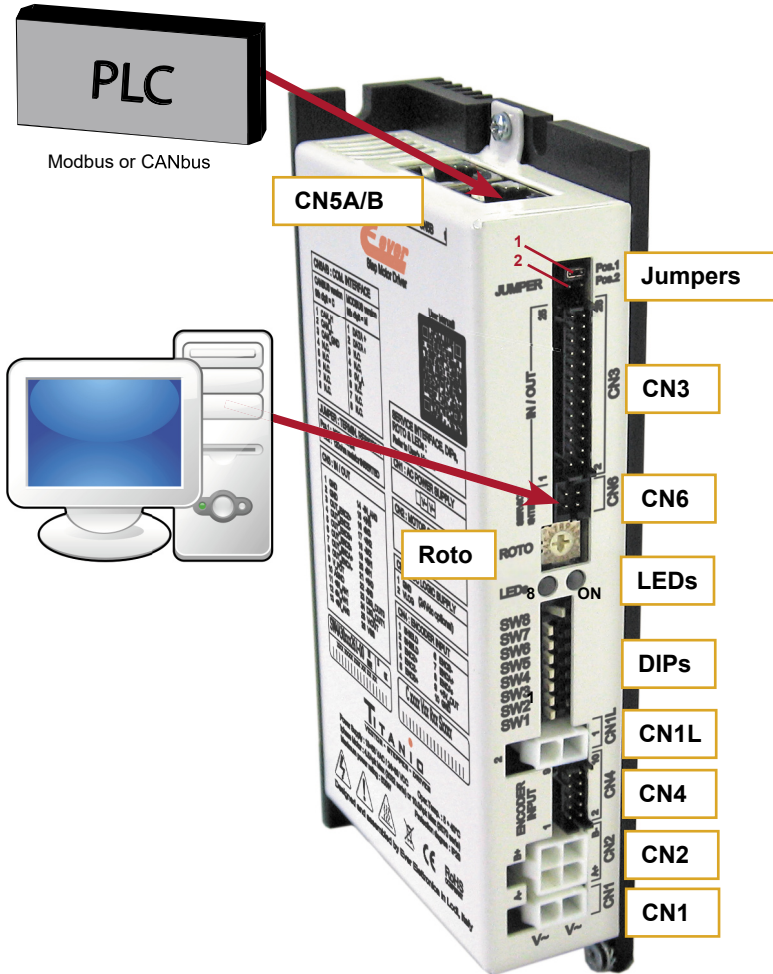

# System connections

Connectors:



-  **Power and Logic supplies are not isolated but they have common reference inside the drive.**
-  **Use two separate and isolated supply for logic and digital outputs.**
-  **Connect GND of the logic supply and VSS of the output supply to PE near to the origin of the supplies with two different wires.**
-  **Do not connect simultaneously PE to the secondary circuit of the power transformer and to GND of the logic supply, otherwise the drive breaks and becomes unusable.**

# System connection

## CN1: Power supply

2 positions, pitch 4.2mm double row, PCB header connector

CN1.1	ACin	PWR_IN	AC power supply input
CN1.2	ACin	PWR_IN	AC power supply input



## CN2: Motor connection

4 positions, pitch 4.2mm double row, PCB header connector

CN2.1	B/	PWR_OUT	Motor output phase B/
CN2.2	A	PWR_OUT	Motor output phase A
CN2.3	B	PWR_OUT	Motor output phase B
CN2.4	A/	PWR_OUT	Motor output phase A/

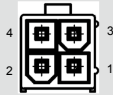

## CN1L: Logic supply

2 positions, pitch 4.2mm double row, PCB header connector

CN1L.1	GND	PWR_IN	Negative DC logic supply input
CN1L.2	VLOG	PWR_IN	Positive DC logic supply input



**Not isolated from the power.**

## CN4: Absolute Encoder Interface

10 positions, pitch 2mm double row, PCB header connector

CN4.1	SHIELD	/	Cable shield connection
CN4.2	SHIELD	/	Cable shield connection
CN4.3	N.C.	/	Not connected
CN4.4	N.C.	/	Not connected
CN4.5	E_DATA+	DIG_IN	Serial data input positive
CN4.6	E_DATA-	DIG_IN	Serial data input negative
CN4.7	E_CLK+	DIG_OUT	Serial clock output positive
CN4.8	E_CLK-	DIG_OUT	Serial clock out negative
CN4.9	+5V	PWR-OUT	+5Vdc power supply output
CN4.10	GND	PWR-OUT	Negative side of supply

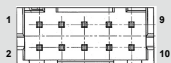

## CN5A e CN5B: CANbus interface ("C" version)

RJ45, 8 positions shielded, PCB header connector

CN5.1	CAN_H	DIGITAL_I/O	Bus line dominant HIGH
CN5.2	CAN_L	DIGITAL_I/O	Bus line dominant LOW
CN5.3	CAN_GND	PWR_OUT	Signal ground
CN5.4	N.C.	---	Not connected
CN5.5	N.C.	---	Not connected
CN5.6	N.C.	---	Not connected
CN5.7	N.C.	---	Not connected
CN5.8	N.C.	---	Not connected

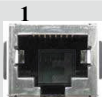

## CN3: Inputs and outputs

26 positions, pitch 2mm double row, PCB header connector

CN3.1	N.C.	N.C.	Not connected
CN3.2	N.C.	N.C.	Not connected
CN3.3	N.C.	N.C.	Not connected
CN3.4	N.C.	N.C.	Not connected
CN3.5	N.C.	N.C.	Not connected
CN3.6	N.C.	N.C.	Not connected
CN3.7	N.C.	N.C.	Not connected
CN3.8	N.C.	N.C.	Not connected
CN3.9	V_POT	PWR_OUT	Voltage supply output for potentiometer
CN3.10	AGND	PWR_OUT	Output negative reference for potentiometer
CN3.11	+IN_AN1	AN_IN	Analog input 1 positive side
CN3.12	-IN_AN1	AN_IN	Analog input 1 negative side
CN3.13	+IN_AN0	AN_IN	Analog input 0 positive side
CN3.14	-IN_AN0	AN_IN	Analog input 0 negative side
CN3.15	+IN3	DIG_IN	Digital input 3 positive side
CN3.16	-IN3	DIG_IN	Digital input 3 negative side
CN3.17	+IN2	DIG_IN	Digital input 2 positive side
CN3.18	-IN2	DIG_IN	Digital input 2 negative side
CN3.19	+IN1	DIG_IN	Digital input 1 positive side
CN3.20	-IN1	DIG_IN	Digital input 1 negative side
CN3.21	+IN0	DIG_IN	Digital input 0 positive side
CN3.22	-IN0	DIG_IN	Digital input 0 negative side
CN3.23	DIG_OUT0	DIG_OUT	PNP digital output OUT0
CN3.24	DIG_OUT1	DIG_OUT	PNP digital output OUT1
CN3.25	V-OUT	PWR_IN	24Vdc supply for digital output
CN3.26	VSS	PWR_IN	Negative input supply for digital output

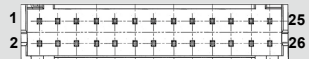

## CN6: Service SCI interface

4 positions, pitch 2mm double row, PCB header connector

CN6.1	TX/RX	Transmit / Receive Line
CN6.2	DE/RE	Drive Enable Negated / Receive Enable
CN6.3	+5V	+5V power out
CN6.4	GND	DNG power out

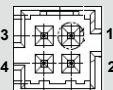

**This connection is only possible with hardware and software provided by Ever.**

## CN5A e CN5B: Modbus interface ("M" version)

RJ45, 8 positions shielded, PCB header connector

CN5.1	Data +	DIGITAL_I/O	Positive RS485 signal
CN5.2	Data -	DIGITAL_I/O	Negative RS485 signal
CN5.3	N.C.	---	Not connected
CN5.4	N.C.	---	Not connected
CN5.5	0V_A	PWR_OUT	Signal ground
CN5.6	N.C.	---	Not connected
CN5.7	N.C.	---	Not connected
CN5.8	N.C.	---	Not connected



## Dip-Switches and Jumper settings

Node ID selection							
SW2	SW3	SW4	SW5	SW6	SW7	SW8	Node ID#
OFF	OFF	OFF	OFF	OFF	OFF	OFF	Not allowed
OFF	OFF	OFF	OFF	OFF	OFF	ON	1 (default)
OFF	OFF	OFF	OFF	OFF	ON	OFF	2
OFF	OFF	OFF	OFF	OFF	ON	ON	3
OFF	OFF	OFF	OFF	ON	OFF	OFF	4
OFF	OFF	OFF	OFF	ON	OFF	ON	5
OFF	OFF	OFF	OFF	ON	ON	OFF	6
OFF	OFF	OFF	OFF	ON	ON	ON	7
...	...	...	...	...	...	...	...
ON	ON	ON	ON	ON	ON	ON	127

U0 Software defined	
SW1	
ON	
OFF	X (default)

Jumpers	
Position	Termination resistor
1	120 ohm resistor NOT inserted (default)
2	120 ohm resistor INSERTED

 **NOTE: the device reads the Dip-Switches only during the power up.**  
If it's necessary a setting change, shut down the system, change the settings and start up the system again to make the changes operating.















## Roto-Switches settings

Modbus version			
Position	Baud rate	Position	Option
0	115200	8	Reserved
1 (default)	57600	9	Reserved
2	38400	A	Reserved
3	19200	B	Reserved
4	9600	C	Reserved
5	4800	D	Reserved
6	2400	E	Reserved
7	1200	F	Reserved

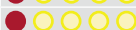
CANbus version			
Position	Baud rate	Position	Option
0	1M	8	Reserved
1 (default)	500K	9	Reserved
2	250K	A	Reserved
3	125K	B	Reserved
4	100K	C	Reserved
5	50K	D	Reserved
6	50K	E	Reserved
7	50K	F	Reserved

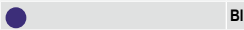
 **NOTE: the device reads the Roto-Switches only during the power up.**  
If it's necessary a setting change, shut down the system, change the settings and start up the system again to make the changes operating.

## Working Status (Led)

Visualization status		Description
1		Green ON Correct functioning.
2		Green BLINKING Enable OFF, current zero
3		Yellow ON Missing setting of Inominal.
4		Yellow BLINKING (500 ms) Warning: connect with Service SCI kit and check with software.
5		Red ON Protection: motor is in open phase condition.
6		Red BLINKING (200 ms) Current protection.
7		Red ON (1 sec) and Yellow 1 BLINK Under/Over voltage protection
8		Red ON (1 sec) and Yellow 3 BLINK Thermal protection
9		Red ON (1 sec) and Yellow 4 BLINK Motor feedback error.
10		Red ON (1 sec) and Yellow 6 BLINK Motor current regulation is out of range.
11		Red ON (1 sec) and Yellow 7 BLINK eePLC User Protection (generated by setting bit#0 of eePLC_User_Settings)
12		Blue ON Error: connected with Service SCI kit and check with software.
13		Blue ON and Yellow ON Drive in boot mode. A new firmware should be downloaded to drive.
14		Blue ON and Red BLINKING (200 ms) Initialization phase. Should last few seconds. While in this condition the drive is not fully operational.

 **Note: Drive could be considered in a correct status if leds Red, Yellow and Blue are all off.**  
In general : - Led Blue indicates a software internal fault or a non-operative condition  
- Led Red indicates an alarm or a drive protection  
- Led Yellow indicates a warning

## Service SCI connection



This connection is only possible with hardware and software provided by Ever.  
Kit code: SW4\_SERV00-SL or SW4-SERV00-EE.

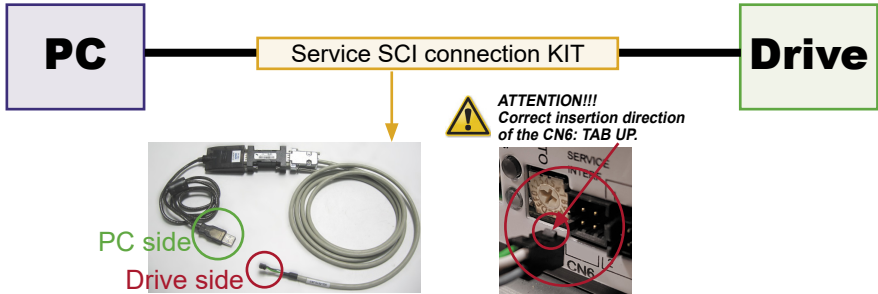

## Absolute encoder interface connection

Electrically NOT-isolated 5V RS485 Full-Duplex interface

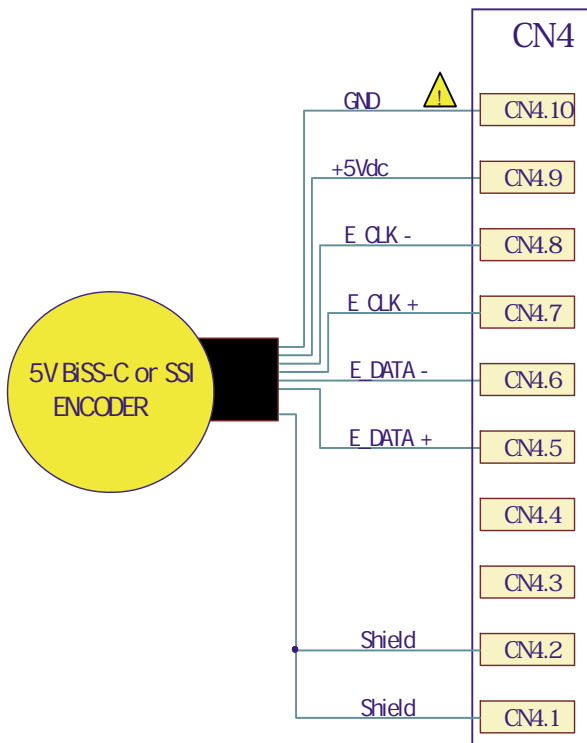

Maximum supply current 100 mA.



GND is internally in common with power ground, this is potentially dangerous. Take all necessary measures to avoid possible contacts in the final installation.

## Digital inputs connection



Differential PNP, NPN and Line Driver type.

### 3.3 - 24V INPUT

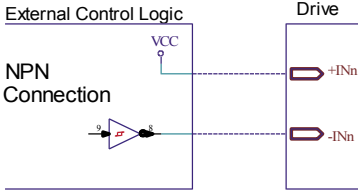
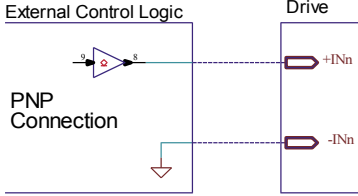

### 2 - 24V INPUT

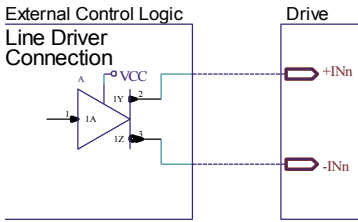

Characteristics	MIN.	MAX.	Unit
Supply voltage	2 <sup>(1)</sup>	24	Vdc
Inputs frequency	--	1	Mhz
Threshold switching voltage	1.61 <sup>(1)</sup>	--	Vdc
Current at 2 Vdc	--	2.53	mA
Current at 3.3 Vdc	--	5.84	mA
Current at 5 Vdc	--	6.28	mA
Current at 24 Vdc	--	8.75	mA

*(1) N.B.: it's recommended to use 2 Vdc digital inputs only in differential Line-Driver configuration to have more noise immunity.*

## Digital outputs connection



Digital outputs are PNP with  $V_{OUTmax} = 24$  Vdc,  $I_{OUTmax} = 100$  mA,  $F_{max} = 500$  KHz.

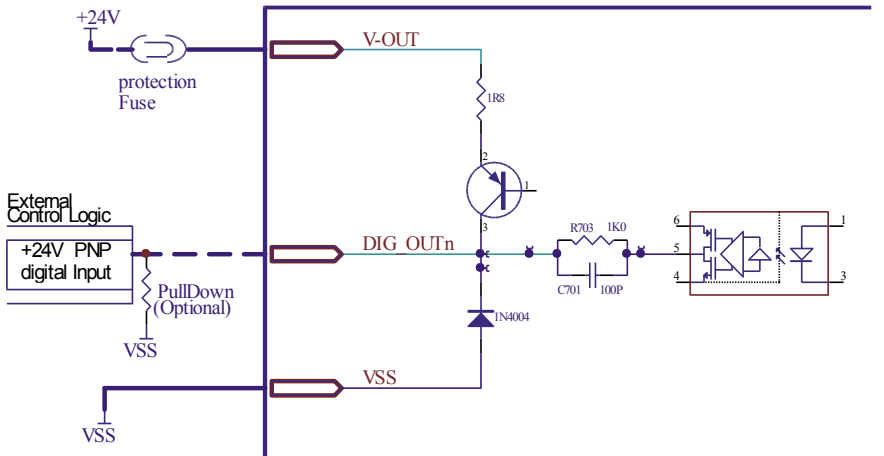

## Analog inputs connection

**i** The resolution of the analog inputs depends from the type of the connection which could be defined by software: differential or potentiometer.

### DIFFERENTIAL CONNECTION

**+/- 10V connection**

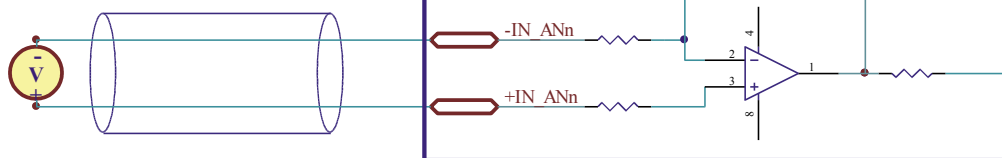

**0-10V / 1-5V connection**

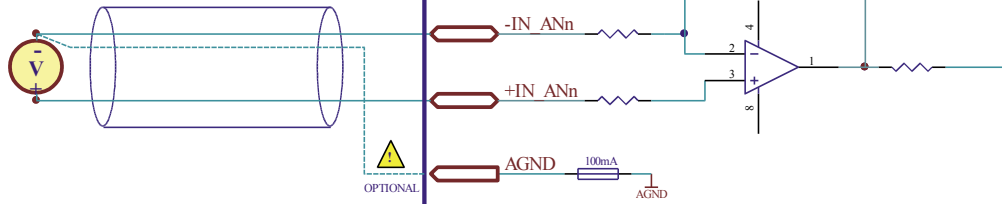

**!** The connection from an external reference and  $AGND$  should be preceded by a thorough risk analysis of the machine/circuit in which the drive will be installed.

### POTENTIOMETER CONNECTION

**Potentiometer connection**

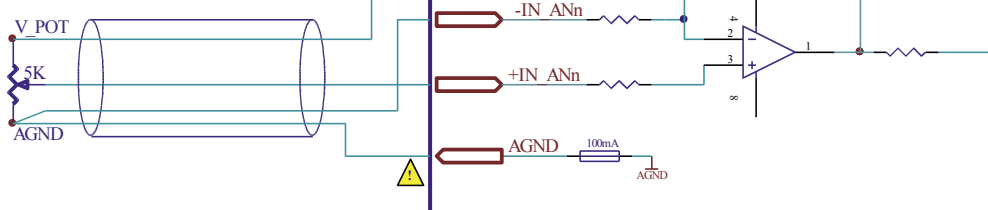

**!**  $AGND$  is internally in common with power ground, this is potentially dangerous. Take all necessary measures to avoid possible contacts in the final installation.

## Mating connectors

Connector	Description
CN1	Molex 39-01-2025
CN1L	Molex 39-01-2025
CN2	Molex 39-01-2045
CN3	Hirose DF11-26DS-2C
CN4	Hirose DF11-10DS-2C
CN5A / CN5B	RJ45, 8 positions

## Section of the cables

Function	Cable	
	Minimum	Maximum
Power supply and PE	0.5 mm <sup>2</sup> (AWG20)	1.3 mm <sup>2</sup> (AWG16)
Motor outputs	0.5 mm <sup>2</sup> (AWG20)	1.3 mm <sup>2</sup> (AWG16)
Encoder input	0.08 mm <sup>2</sup> (AWG28)	0.2 mm <sup>2</sup> (AWG24)
Inputs and Outputs	0.08 mm <sup>2</sup> (AWG28)	0.2 mm <sup>2</sup> (AWG24)
Communication interfaces	0.25 mm <sup>2</sup> (AWG23) CANbus CiA Canopen	0.25 mm <sup>2</sup> (AWG23) CANbus CiA Canopen

## Verify the installation

- Check all connection: power supply and inputs/outputs.
- Make sure all settings right for the application.
- Make sure the power supply is suitable for the drive.
- If possible, remove the load from the motor shaft to avoid that wrong movements cause damage.
- Enable the current to the motor and verify the applied torque.
- Enable a movement of some steps and verify if the rotation direction is the desired one.
- Disconnect the power supply, connect the load on the motor and check the full functionality.

## Analysis of malfunctions



*When any of the following situations occur, the drive is placed in a fault condition.*

DEFECT	CAUSE	ACTION
Intervention of the thermal protection.	Can be caused by a heavy working cycle or a high current in the motor.	Improve the drive cooling by a natural or fan air flow. Consider to use a motor with a higher torque vs current rating.
Intervention of the current protection.	Short circuit on the motor powering stage(s) of the drive.	Check motor windings and cables to remove the short circuits replacing faulty cables or motor if necessary.
Intervention of the over/under voltage protection	Supply voltage out of range.	Check the value for the supply voltage.
Open phase motor protection.	Motor windings to drive not proper connection.	Check motor cables and connections to the drive.



*When any of the following situations occur, the drive doesn't work and isn't placed in an error condition.*

DEFECT	CAUSE	ACTION
Noisy motor movement with vibrations.	Can be caused by a lack of power supply to a phase of the motor or a poor regulation of the winding currents.	Check the cables and connections of the motor and/or change the motor speed to avoid a resonance region.
The external fuse on the power supply of the drive is burned.	Can be caused by a wrong connection of the power supply.	Connect the power supply correctly and replace the fuse.
At high speed, the motor torque is not enough.	Can be due to a 'self-limitation' of motor current and torque.	Increase the motor current (always within the limits), increase the supply voltage, change motor connection from series to parallel.

## Ever Motion Solutions

Via del Commercio, 2/4 - 9/11

Loc. San Grato Z. I

26900 - L O D I - Italy

Phone +39 0371 412318 - Fax +39 0371 412367

email: infoever@everelettronica.it

web: www.everelettronica.it

