

Installation instructions



Refer to installation use and maintenance manual for more information.



2 phase stepper drive technical data:

- AC power supply: 18 ± 100 Vac (mono or three-phase)
- AC logic supply: 18 ± 100 Vac (optional and not isolated) (monophase)
- Phase current: up to 8.5 Arms (12 Apeak)
- Chopper frequency: ultrasonic 40 kHz
- Stepless Control Technology (65536 position per turn)
- Protections against: over current, over/under voltage, overheating, short circuit between motor phase-to-phase and phase-to-ground
- Ethernet communication interface (Modbus TCP protocol)
- Encoder input (not isolated): 5V Differential (RS422) or 5V Single-Ended (TTL/CMOS) incremental encoder
- Service SCL interface for programming and real time debugging
- Up to 12 digital opto-coupled inputs (only SW5A4085E2J1-00) or 4 digital opto-coupled inputs (SW5A4085E241-00)
- Up to 10 digital opto-coupled outputs (only SW5A4085E2J1-00) or 2 digital opto-coupled outputs (SW5A4085E241-00)
- Dimensions: 165 x 120 x 48 mm (without connectors)
- Protection degree: IP20
- Pollution degree: 2
- Category C3 following standard EN 61800-3
- Working temperature $5^{\circ}\text{C} \pm 40^{\circ}\text{C}$; Storage temperature $-25^{\circ}\text{C} \pm 55^{\circ}\text{C}$
- Humidity: 5% + 85% not condensing

TITANIO
VECTOR - STEPPER - DRIVES

error
less
servo
efficient
else
technology
by Ever Electronics



Mechanical data

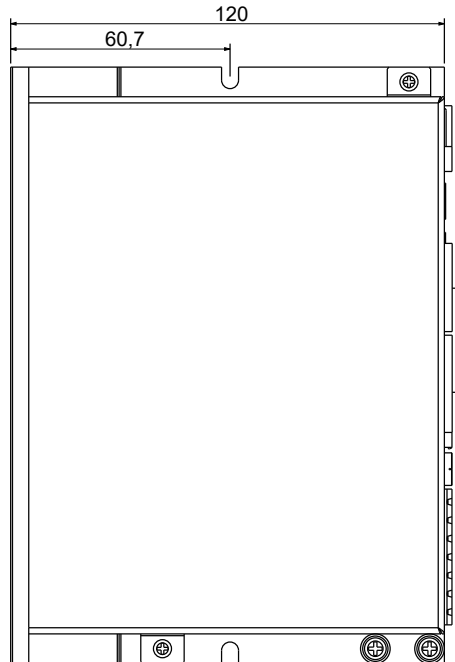
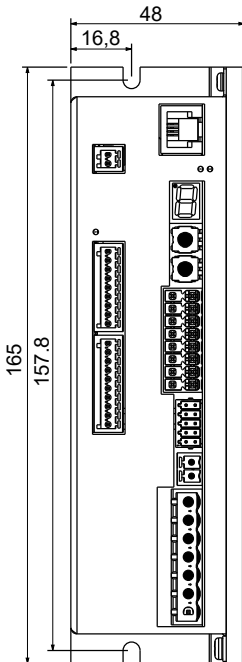

System connections

Connectors:

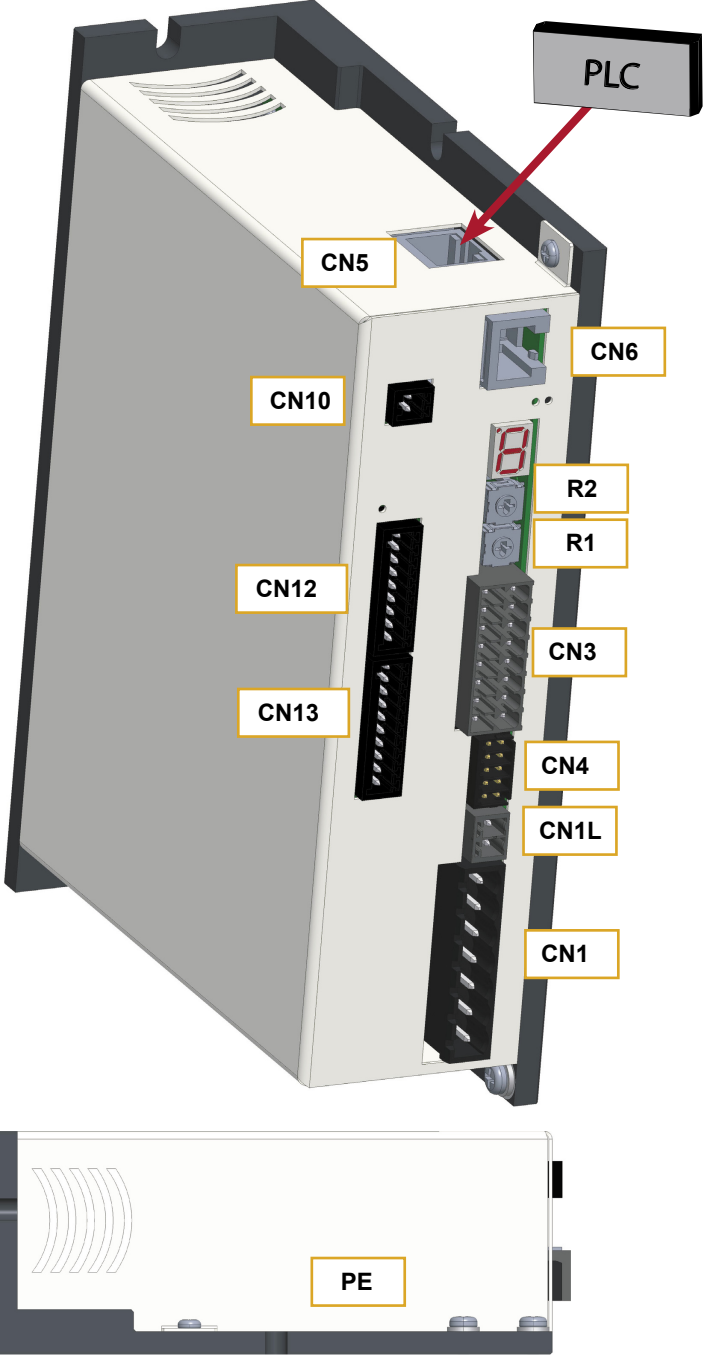

System connection

CN1: AC Power supply & Motor

7 positions, pitch 5.08mm, PCB header connector

CN1.1	ACin	PWR_IN	AC power supply input (18-100Vac)
CN1.2	ACin	PWR_IN	AC power supply input (18-100Vac)
CN1.3	ACin	PWR_IN	AC power supply input (18-100Vac)
CN1.4	A	PWR_OUT	Motor output phase A
CN1.5	A/	PWR_OUT	Motor output phase A/
CN1.6	B	PWR_OUT	Motor output phase B
CN1.7	B/	PWR_OUT	Motor output phase B/

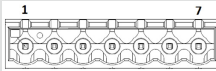

CN1L: AC Logic Supply

2 positions, pitch 3.81mm, PCB header connector

CN1L.1	AClog	PWR_IN	AC logic supply input (18-100Vac)
CN1L.2	VLOG	PWR_IN	AC logic supply input (18-100Vac)



CN3: Digital Inputs / Outputs

16 positions, pitch 3.5mm double row, PCB header connector

CN3.1	+B0_IN3	DIG_IN	Digital input B0_IN3 positive side
CN3.2	-B0_IN3	DIG_IN	Digital input B0_IN3 negative side
CN3.3	+B0_IN2	DIG_IN	Digital input B0_IN2 positive side
CN3.4	-B0_IN2	DIG_IN	Digital input B0_IN2 negative side
CN3.5	+B0_IN1	DIG_IN	Digital input B0_IN1 positive side
CN3.6	-B0_IN1	DIG_IN	Digital input B0_IN1 negative side
CN3.7	+B0_IN0	DIG_IN	Digital input B0_IN0 positive side
CN3.8	-B0_IN0	DIG_IN	Digital input B0_IN0 negative side
CN3.9	B0_OUT0	DIG_OUT	PNP digital output B0_OUT0
CN3.10	B0_OUT1	DIG_OUT	PNP digital output B0_OUT1
CN3.11	V-OUT	PWR_IN	24Vdc input supply for digital output
CN3.12	VSS	PWR_IN	Negative input supply for digital output
CN3.13	n.c.		Not connected
CN3.14	n.c.		Not connected
CN3.15	n.c.		Not connected
CN3.16	n.c.		Not connected

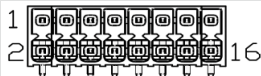

CN4: Encoder input connection

10 positions, pitch 2.54mm double row, PCB header connector

CN4.1	SHIELD	/	Cable shield connection
CN4.2	SHIELD	/	Cable shield connection
CN4.3	ENCZ+	DIG_IN	Encoder Zero input positive
CN4.4	ENCZ-	DIG_IN	Encoder Zero input negative
CN4.5	ENCB+	DIG_IN	Encoder Phase B input positive
CN4.6	ENCB-	DIG_IN	Encoder Phase B input negative
CN4.7	ENCA+	DIG_IN	Encoder Phase A input positive
CN4.8	ENCA-	DIG_IN	Encoder Phase A input negative
CN4.9	+5V	PWR_OUT	+5Vdc power supply output
CN4.10	GND	PWR_OUT	Negative side of supply



CN10: I/O Expansion Supply (see drive version)

2 positions, pitch 2.5mm, PCB header connector

CN10.1	+24V	PWR_IN	24Vdc supply for I/O expansion
CN10.2	VSS#2	PWR_IN	Negative supply for I/O expansion and negative reference for digital I/O B1



CN12: Digital Outputs B1 (see drive version)

9 positions, pitch 2.5mm, PCB header connector

CN12.1	B1_OUT0	DIG_OUT	PNP digital output B1_OUT0
CN12.2	B1_OUT1	DIG_OUT	PNP digital output B1_OUT1
CN12.3	B1_OUT2	DIG_OUT	PNP digital output B1_OUT2
CN12.4	B1_OUT3	DIG_OUT	PNP digital output B1_OUT3
CN12.5	B1_OUT4	DIG_OUT	PNP digital output B1_OUT4
CN12.6	B1_OUT5	DIG_OUT	PNP digital output B1_OUT5
CN12.7	B1_OUT6	DIG_OUT	PNP digital output B1_OUT6
CN12.8	B1_OUT7	DIG_OUT	PNP digital output B1_OUT7
CN12.9	VSS#2	PWR_IN	Negative reference of expansion digital outputs B1

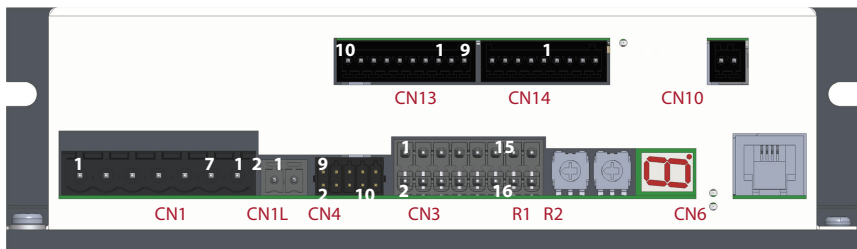
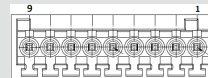

System connections

CN13: Digital Inputs B1 (see drive version)

10 positions, pitch 2.5mm, PCB header connector

CN13.1	B1_IN0	DIG_IN	Digital input B1_IN0
CN13.2	B1_IN1	DIG_IN	Digital input B1_IN1
CN13.3	B1_IN2	DIG_IN	Digital input B1_IN2
CN13.4	B1_IN3	DIG_IN	Digital input B1_IN3
CN13.5	B1_IN4	DIG_IN	Digital input B1_IN4
CN13.6	B1_IN5	DIG_IN	Digital input B1_IN5
CN13.7	B1_IN6	DIG_IN	Digital input B1_IN6
CN13.8	B1_IN7	DIG_IN	Digital input B1_IN7
CN13.9	B1_COM_IN	PWR_IN	Reference common digital inputs B1
CN13.10	VSS#2	PWR_IN	Negative reference of expansion digital inputs B1

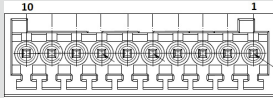

CN5: Ethernet Interface

RJ45, 8 positions shielded, PCB header connector

RJ45 connector
100BASE-TX (100Mb/sec) port
Accept standard Ethernet cable (CAT5 or higher)



CN6: Service SCI Interface

RJ11, 6P4C, PCB header connector

CN6.1	TX/RX	Transmit / Receive Line
CN6.2	DE/RE	Drive Enable Negated /Receive Enable
CN6.3	+5V	+5V power out
CN6.4	GND	GND power out



This connection is only possible with hardware and software provided by Ever.



Service SCI connection



This connection is only possible with hardware and software provided by Ever.
Kit code: **SW5_SERV00-SL** or **SW5-SERV00-EE**.

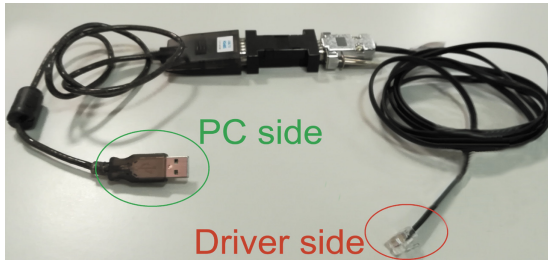

Roto-Switches settings

Ethernet IP Address (Last Significant Byte in Hexadecimal Value)										
R1 x 16	0	0	0	0	2	2	F	F
R2 x 1	0	1	2	3	C	D	E	F
IP Address	SW settings (default)	1	2	3	44	45	254	255

x 16
(MSD)
R1

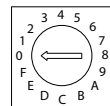

x1
(LSD)
R2

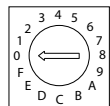

R1 (MSD): Most Significant Digit that must be multiplied per 16.

R2 (LSD): Least Significant Digit that must be multiplied per 1.

Example: 5C

R1 = 5 ----> 5x16 = 80

R2 = C ----> 12x1 = 12

IP Address (Least Significant Byte) = 92

Display Status

Operational statuses and their signals

0	Missing Operating System: no software application stored on drive
1	Firmware update: Updating of new software in progress.
2	Initialization: the drive executes the start-up procedure (a few seconds after the start-up procedure has begun).
3	Correct functioning
4	Voltage of DC bus near to the limit value (minimum or maximum)
5	Drive temperature is near to the maximum value
6	EEprom near Write Overrun
7	EEprom near End of Life
8	Enable OFF, current zero
9	$I_{nominal}$ not computed
A	Error: expired eePLC software trial
B	Security intervention of watchdog
C	Internal Software Error
D	Missing calibration values
E	Management EEPROM
F	EEPROM fail
10	eePLC application error
11	EEprom Write Overrun
12	Feature unavailable
13	Open motor phases
14	Over/under voltage;
15	Over current on the motor output;
16	Over temperature of the drive;
17	Mising Torque Enable ("missing Safe Torque Off")
18	Drive Over Power Protection and/or Current Regulation out of range
19	eePLC User Protection (generated by setting bit #0 of eePLC_User_Settings)
20	Motor feedback error

Encoder input connection

Electrically NOT-isolated digital inputs:

- differential 5Vdc that meet the RS422 standard
- single-ended 5Vdc TTL/CMOS

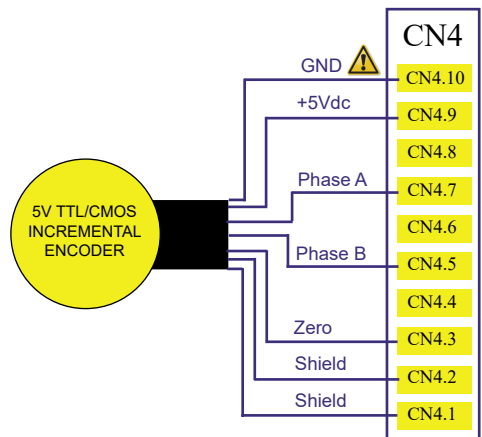
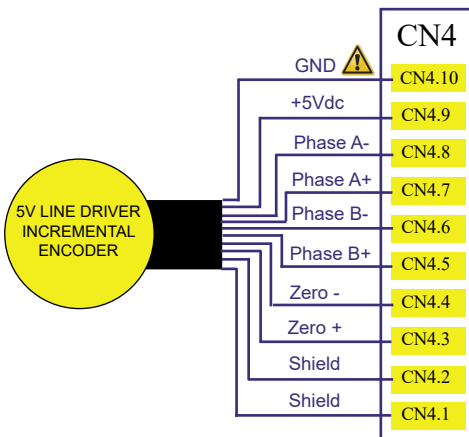

GND is internally in common with power ground, this is potentially dangerous. Take all necessary measures to avoid possible contacts in the final installation.

Digital inputs connection

Digital input connection (B0_IN0 to B0_IN3)

i Differential PNP, NPN and Line Driver type.

3.3 - 24V INPUT

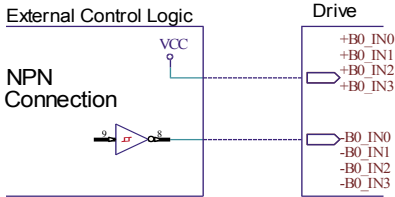
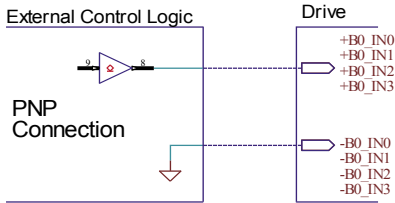

2 - 24V INPUT

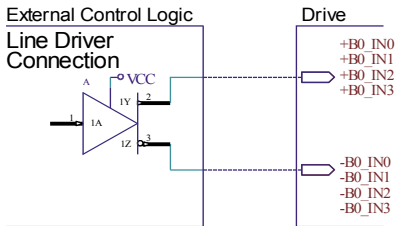

Standard Digital Inputs (B0_IN0 and B0_IN1)

Characteristics	MIN.	MAX.	Unit
Supply voltage	2 ⁽¹⁾	24	Vdc
Inputs frequency	--	10	kHz
Threshold switching voltage	1.61 ⁽¹⁾	--	Vdc
Current at 2 Vdc	--	2.53	mA
Current at 3.3 Vdc	--	5.84	mA
Current at 5 Vdc	--	6.28	mA
Current at 24 Vdc	--	8.75	mA

High-Speed Digital Inputs (B0_IN2 and B0_IN3)

Characteristics	MIN.	MAX.	Unit
Supply voltage	2 ⁽¹⁾	24	Vdc
Inputs frequency	--	500	kHz
Threshold switching voltage	1.61 ⁽¹⁾	--	Vdc
Current at 2 Vdc	--	2.53	mA
Current at 3.3 Vdc	--	5.84	mA
Current at 5 Vdc	--	6.28	mA
Current at 24 Vdc	--	8.75	mA

(1) N.B.: it's recommended to use 2Vdc digital inputs only in differential Line-Driver configuration to have more noise immunity.

Digital inputs connection (B0_IN4 to B0_IN7)

i Single-Ended PNP, NPN, Push-Pull

5 - 24V INPUT

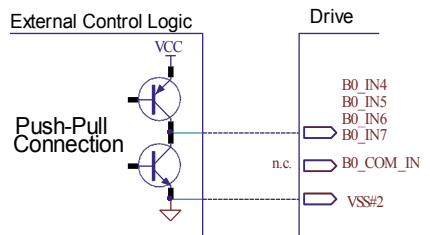
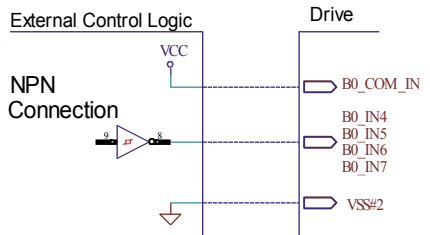
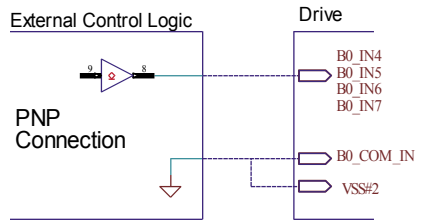

Low-Speed Digital Inputs (B1_IN0 to B1_IN7)

Characteristics	MIN.	MAX.	Unit
Supply voltage	5	24	Vdc
Inputs frequency	--	250	Hz
Threshold switching voltage	2,5	--	Vdc
Current at 5 Vdc	--	2	mA
Current at 24 Vdc	--	12	mA

N.B.: All these inputs must be connected with the same configuration (PNP, NPN or Push-Pull).

Digital outputs connection

Digital outputs connection (B0_OUT0 and B0_OUT1)

i PNP with $V_{OUTmax}=24Vdc$, $I_{OUTmax}=100mA$, $F_{max} = 40kHz$

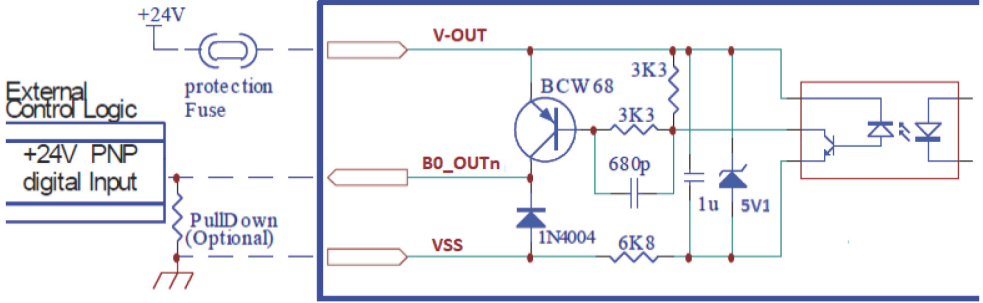

Digital outputs connection (B1_OUT0 and B1_OUT7)

i PNP with $V_{OUTmax} = 24Vdc$, $I_{OUTmax} = 100mA$, $F_{max} = 250Hz$

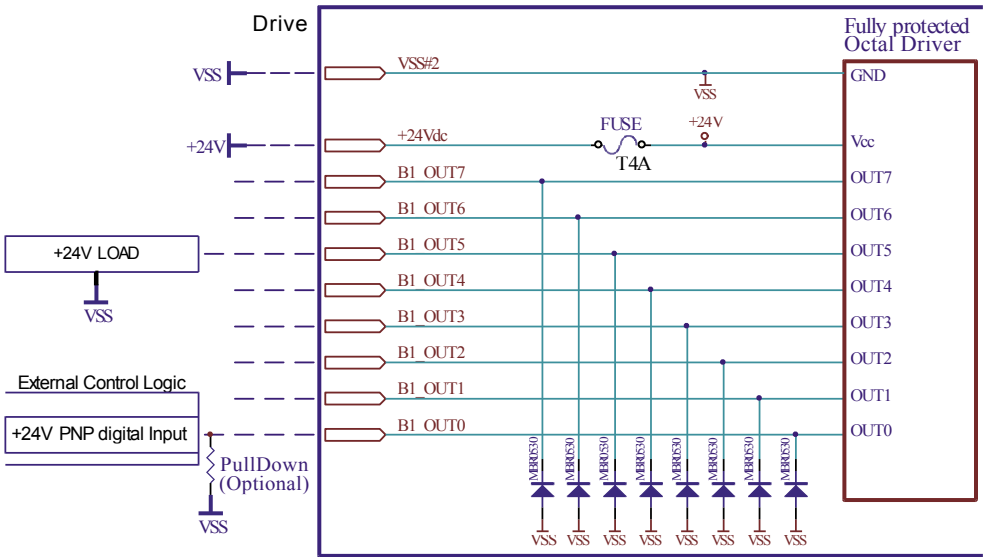

Mating connectors

Connector	Description
CN1	Phoenix 1758623
CN1L	Phoenix 1827635
CN3	Weidmuller 1727690000
CN4	Phoenix 1844604
CN5	RJ45 for Ethernet standard cables (CAT5 or higher)
CN12	Phoenix 1701061
CN13	Phoenix 1700841

Section of the cables

Function	Cable	
	Minimum	Maximum
Power supply, Motor output and PE	0.50 mm ² (AWG20)	2.50 mm ² (AWG12)
Logic supply	0.14 mm ² (AWG26)	1.50 mm ² (AWG16)
Encoder input	0.14 mm ² (AWG26)	0.50 mm ² (AWG20)
Digital Inputs / Outputs and STO	0.20 mm ² (AWG24)	1.30 mm ² (AWG16)
Ethernet interfaces	Ethernet standard cables CAT5 or higher	
I/O Expansion	0.14 mm ² (AWG26)	0.50 mm ² (AWG20)

Verify the installation

- Check all connection: power supply, logic supply, STO inputs and inputs/outputs
- Make sure all settings right for the application.
- Make sure the power supply is suitable for the drive.
- If possible, remove the load from the motor shaft to avoid that wrong movements cause damage.
- Enable the current to the motor and verify the applied torque.
- Enable a movement of some steps and verify if the rotation direction is the desired one.
- Disconnect the power supply, connect the load on the motor and check the full functionality.

Analysis of malfunctions



When any of the following situations occur, the drive is placed in a fault condition.

DEFECT	CAUSE	ACTION
Intervention of the thermal protection.	Can be caused by a heavy working cycle or a high current in the motor.	Improve the drive cooling by natural or fan air flow. Consider to use a motor with a higher torque vs current rating.
Intervention of the current protection.	Short circuit on the motor powering stage(s) of the drive.	Check motor windings and cables to remove the short circuits replacing faulty cables or motor if necessary.
Intervention of the over/under voltage protection.	Supply voltage out of range	Check the value of the supply voltage
Open phase motor protection.	Motor windings to drive not proper connection.	Check motor cables and connections to the drive.



When one of the following situations occur, the drive doesn't function correctly and it is reported an error.

DEFECT	CAUSE	ACTION
Noisy motor movement with vibrations.	Can be caused by a lack of power supply to a phase of the motor or a poor regulation of the winding currents.	Check the cables and connections of the motor and/or change the motor speed to avoid a resonance region.
The external fuse on the power supply of the drive is burned.	Can be caused by a wrong connection of the power supply.	Connect the power supply correctly and replace the fuse.
At high speed, the motor torque is not enough.	Can be due to a "self-limitation" of motor current and torque.	Increase the motor current (always within the limits), increase the supply voltage, change motor connection from series to parallel.

Ever Motion Solutions

Via del Commercio, 2/4 - 9/11
 Loc. San Grato Z. I
 26900 - L O D I - Italy
 Phone +39 0371 412318 - Fax +39 0371 412367
 email: infoever@everelettronica.it
 web: www.everelettronica.it

